

GROWING GRAPES IN WISCONSIN

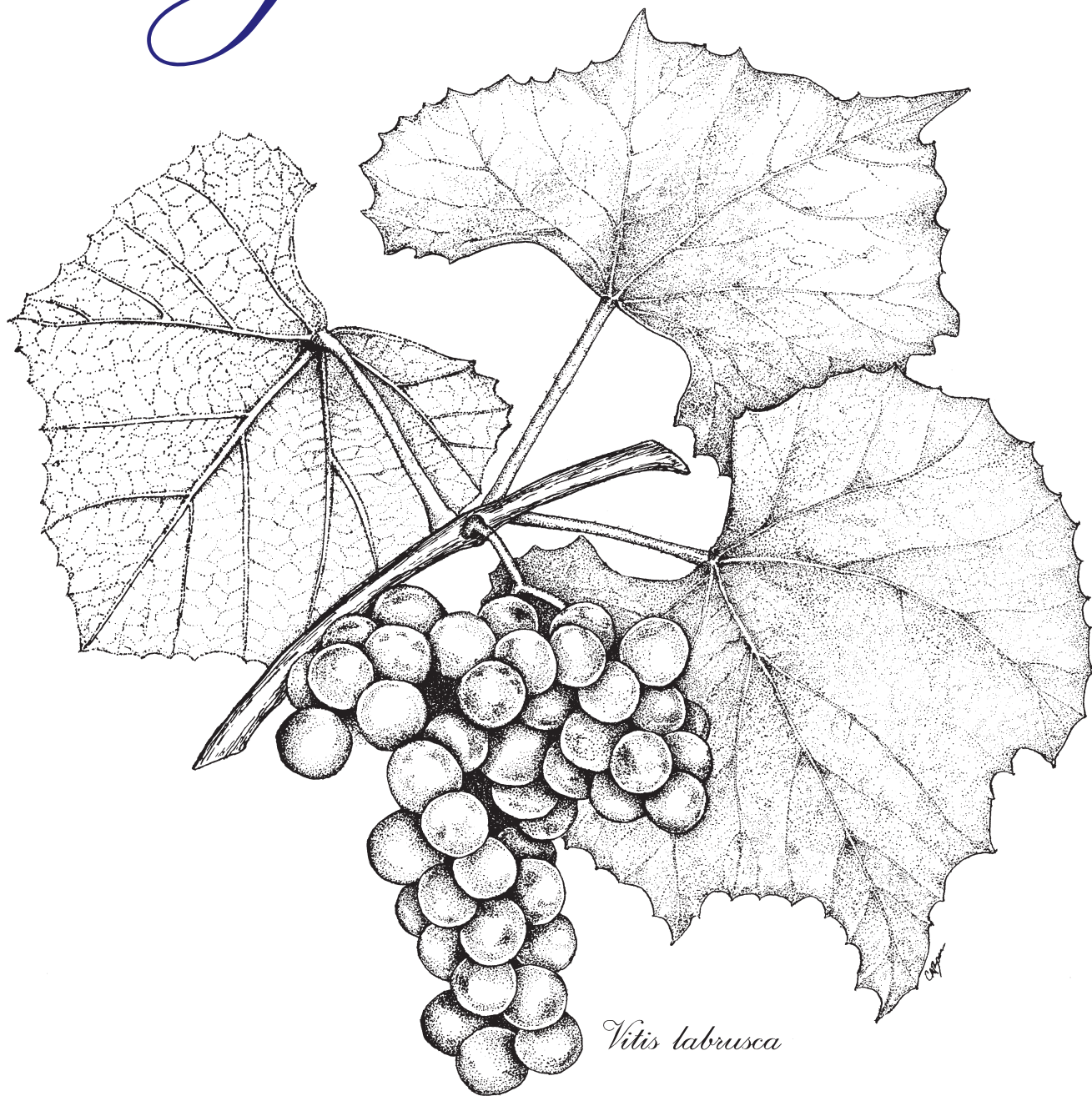

TERYL R. ROPER, DANIEL L. MAHR, PATRICIA S. MCMANUS, BRIAN R. SMITH

CONTENTS



<i>The grape plant</i>	<i>.2</i>
<i>Site selection and soil preparation</i>	<i>.3</i>
<i>Cultivar selection</i>	<i>.3</i>
<i>Planting stock and propagation</i>	<i>.6</i>
<i>Planting design and row spacing</i>	<i>.6</i>
<i>Planting</i>	<i>.7</i>
<i>Soil management and weed control</i>	<i>.7</i>
<i>Fertilization</i>	<i>.8</i>
<i>Flowering and fruit set</i>	<i>.8</i>
<i>Harvesting and storage</i>	<i>.8</i>
<i>Trellis construction</i>	<i>.9</i>
<i>Training and pruning</i>	<i>.11</i>
<i>Managing grapevines in cold climates</i>	<i>.15</i>
<i>Insect pests</i>	<i>.16</i>
<i>Diseases</i>	<i>.18</i>
<i>Problem solving</i>	<i>.23</i>
<i>Glossary</i>	<i>.25</i>
<i>Related publications</i>	<i>back cover</i>
<i>Nurseries</i>	<i>back cover</i>



Grapes, one of the oldest cultivated plants in the world, can grow in all but northernmost Wisconsin. However, success depends on using adapted cultivars (cultivated varieties), choosing an ideal site, and carefully following proven cultural practices.

While grapes are a good crop for home use or limited local cash markets, they are a risky commercial crop. Periodically, harsh

Wisconsin winters will substantially injure vines, ending production for one or more seasons. Spring frosts or freezes frequently damage new growth. The hardiest cultivars usually regrow rapidly after winter or spring injury, but other cultivars may be completely killed. *Vitis vinifera* grapes, which are used for wine production, are not hardy in Wisconsin.

THE GRAPE PLANT

The grape is a woody perennial vine. Perennial portions of the plant include the roots, trunk, and perhaps cordons. Fruit are produced on current season's shoots. These shoots arise from compound buds that are produced at a leaf base or axil a year earlier. The compound bud must survive the winter to produce fruit and vegetative growth the following year. After leaf fall the dormant primary shoot is called a cane.

The compound bud is really one large bud surrounded by two to five smaller buds. These are all enclosed in one set of bud scales. If frost kills the large bud of the group in the spring, a second bud may produce a smaller crop of fruit. If both the primary and secondary bud are injured or killed, vegetative growth can still continue from one of the smaller buds, but no fruit will be produced. In this case vegetative growth may be excessive as all of the strength of the vine is channeled into vegetative growth.

The most common cultivated grapes in Wisconsin are the American types (*Vitis labrusca*). Most American grapes are hardy throughout Wisconsin. For the crop to mature, select early-maturing cultivars. American grapes typically produce two to four flower clusters per shoot, on shoots produced at the second to fifth node from the cane base. To retain productive flower clusters, leave fewer longer canes at pruning.

French hybrid types can be grown in protected sites in southern Wisconsin. These types produce fruit on shoots that arise from the first to third nodes from the base of the cane. To obtain good yields from these vines, leave more shorter canes when pruning.

Wild American grape vines are found throughout Wisconsin. Some wild grape vines produce satisfactory fruit. Some wild grapes are dioecious, meaning they have separate male and female plants. Male plants will never produce fruit. They can be identified at blossom by the absence of a stigma, style, and ovary in the flowers. With these exceptions, the male and female plants are identical.

The grape vine must be supported. A post, wall, fence, trellis, or arbor are all satisfactory. Support keeps the plant at working height and most importantly spreads the growth so that more leaves are exposed to sunlight. It also improves aeration and makes insect control easier. Yields should range from 5 to 30 pounds of fruit per vine or 2 to 8 tons per acre depending on site, cultivar, and management expertise.

SITE SELECTION AND PREPARATION

Since grapes are a perennial crop, the vines can't easily be moved once they are planted. Site selection and preparation are particularly important. Soil preparation should begin the season before planting. Planning ahead allows time to adjust the soil pH, control perennial weeds, and amend the soil.

When selecting a site, consider space requirements. Grapes grown on a trellis occupy wide, shallow spaces. Allow 10 to 14 feet of trellis space per vine. As the canes grow in the summer they will fill out 2 to 3 feet on either side of the trellis.

The ideal site for grapevines is on gently sloping land that will allow cold air to drain into adjacent lower areas. Southern exposures with a gentle slope are ideal. The bottoms of valleys are "frost pockets" and may be several degrees colder than adjacent hillsides. Hilltops are undesirable as they may be windy, but the wind can be tempered with windbreaks. Grapes grow best in sandy or gravelly loam soils, but they will grow in all but the rockiest or heaviest clay soils. Grapes will not survive long on heavy clay soils with poor internal drainage. Sandy soils may have difficulty retaining moisture and nutrients. Tiling to improve drainage is rarely justified for grapes. Grapes do best in sunny locations and will not thrive in shade.

The first step in soil preparation is amending the soil. To determine soil nutrient needs, submit a sample for testing. Sample to a depth of 6 inches. For information on how to collect representative

samples and where to send them, see Extension publication *Sampling Lawn and Garden Soils for Soil Testing* (A2166). Follow soil test recommendations to adjust the pH to a level between 6 and 7. Add fertilizer if called for in the soil test. Grape soils should have 25 ppm available phosphorus and 100 ppm available potassium. To improve soil tilth, aeration and water holding capacity, add and incorporate organic matter such as manure, compost, or green manure crops.

The season before planting is also the best time to control perennial weeds such as quackgrass and Canada thistle. Use a non-residual systemic herbicide or tillage to control these weeds. If a hardpan is present, till to a depth of 18 inches in perpendicular directions.

For large plantings, seed the area to perennial rye in the late summer so it will establish a turf before winter. This will prevent erosion during the winter and will facilitate planting in the spring by creating a firm surface. If possible, lay out the rows in the late fall and kill the sod in the planting strips to a width of about 3 to 4 feet.

CULTIVAR SELECTION

Choosing grape cultivars for Wisconsin is a compromise of hardiness, early maturing fruit, and the quality and flavor of the grape. Of the hundreds of grape cultivars available, many will grow in Wisconsin but only a few are consistently productive in Wisconsin's rigorous climate.

The well-known Concord grape, for example, will grow and produce fruit in Wisconsin, but requires a 155- to 160-day growing season for the fruit to ripen. Concord will ripen to best quality only in southern Wisconsin and only two or three years out of every five. Concord vines and shoots are injured at temperatures below -20°F .

The following cultivars are recommended for growing in Wisconsin in the zones indicated in figure 1. Cultivars of each type are listed in order of ripening. The more hardy American types are most likely to be successful. French hybrid types are suggested for trial plantings only.

FIGURE 1. Hardiness zones for Wisconsin.

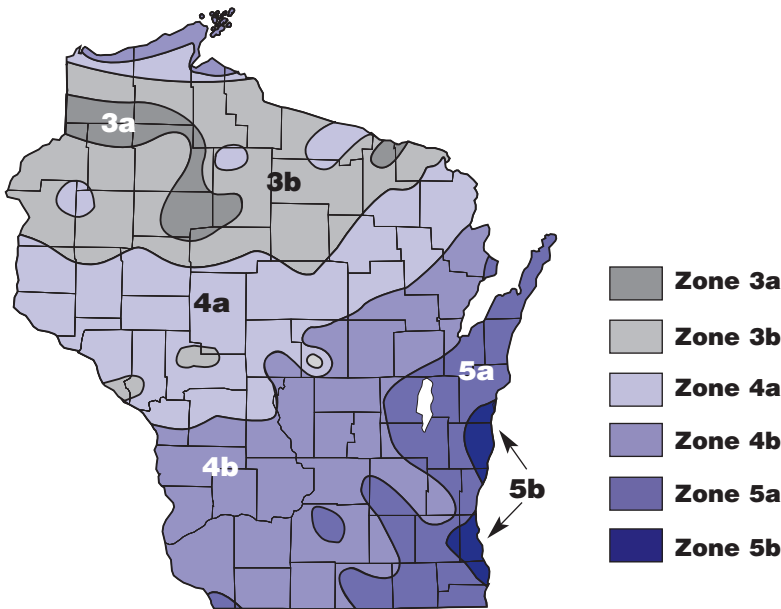

AMERICAN GRAPES

Blue- or black-fruited cultivars

Buffalo **Zone 5b**

One of the best American grapes. Excellent for table use or juice. Medium to large, well-filled clusters with medium-sized berries. Spicy sweet melting, nonfoxy flavor. Vigorous, disease-resistant vine. Ripens early September. Cane prune.

Valiant **Zone 3a**

Medium-sized, tart fruit in small clusters. Used primarily for jams and jellies. Plant is vigorous, very hardy, and productive. Ripens early September. Hardier than Beta. Cane prune.

Bluebell **Zone 4a**

Attractive, dark blue berries are medium to large; slipskin type. Juicy with a pleasant fresh flavor. Makes an excellent jelly and light red juice. Ripens early to mid-September. Very hardy. Cane prune.

Beta **Zone 3b**

Hardy, vigorous, disease resistant, productive. Small, tart fruit is best suited for jelly. Ripens mid- to late September. Cane prune.

Fredonia **Zone 4b**

Medium to large fruit with excellent flavor. Used to make a high-quality, unfermented juice. Plant is vigorous and moderately productive. Susceptible to downy mildew. Ripens mid-September. Cane prune.

St. Croix **Zone 4b**

Medium to large bunches of small berries. Good flavor with low acid content. The juice is pale rose. Suitable for winemaking and dessert. Very productive with a trailing growth habit. Ripens mid-September. Cane prune.

King of the Hill **Zone 4b**

Productive and vigorous vines. Medium-sized, dark blue berries are juicy and tart; borne in tight clusters. Excellent for juice and jelly. Appears to be quite tolerant of common grape pests. One of the best of type in Wisconsin trials. Cane prune.

Worden **Zone 5a**

Moderately productive, small clusters with large berries. Fruit has sprightly, rich flavor. Good for juice and jelly. Medium vine vigor, needs less space than other cultivars. Ripens mid- to late September. Cane prune.

Concord **Zone 5a**

The standard of flavor and quality for American blue grapes when fruit is fully matured. Good for juice and jelly. Very susceptible to black rot and phomopsis cane and leaf spot. Vigorous and productive vine. Ripens early October, often too late to mature before killing frost. Cane prune.

White-, yellow-, and green-fruited cultivars

Himrod **Zone 5b**

Not fully hardy, may often be winter-injured. Large, loose clusters with small, nearly seedless, sweet berries. Suitable for wine and table use. Very productive when not winter-injured. Ripens mid- to late August. Cane prune.

Kay Gray **Zone 4b**

Small fruit clusters with medium-sized, seeded berries. Fruit has distinctive, pungent flavor. Suitable for wine and table use. Vigorous vine with trailing growth habit. Ripens somewhat unevenly in late August. For trial plantings only. Cane prune.

Edelweiss **Zone 4b**

A large-clustered white Swenson-hybrid grape suitable for wine and table use. Harvest early for best flavor. Vines are vigorous and moderately productive. Cane prune.

La Crosse **Zone 4b**

A white Swenson-hybrid grape. Good for fruity wine. Moderate production and vigor. Ripens early to mid-September. For trial plantings only. Cane prune.

Esprit **Zone 4b**

Vigorous grape with mild, fruity flavor. Good for table or wine use. Ripens mid- to late September. For trial plantings only. Cane prune.

Red-fruited cultivars

Reliance **Zone 5b**

Seedless red grape. Medium-sized clusters with medium to large berries. Fruit is moderately sweet when fully mature, good for table use. Very susceptible to black rot and downy mildew. Ripens mid-September. Cane prune.

Frontenac **Zone 4a**

From the University of Minnesota. Easy to manage with vigorous growth habit. Productive and quite disease tolerant. Produces aromatic wine reminiscent of cherry or berry. Ripens mid- to late September. Cane prune. For trial use.

Swenson's Red **Zone 5a**

Moderately hardy, seeded grape. Medium to large clusters with thin-skinned berries. Mild-flavored, can be refrigerated up to 3 weeks. For fresh use. Fruit develops color unevenly and should be left on vine until fully mature. Susceptible to downy mildew and phylloxera. Ripens late September. Cane prune.

FRENCH HYBRID GRAPES

Today's numerous French hybrid grapes are products of breeding programs designed to blend the disease and insect resistance of American grapes with the table and wine qualities of the European grape species and are suited almost exclusively for winemaking. In general, **French hybrid grapes are not hardy in Wisconsin and are not suggested for extensive planting.** For the avid hobbyist willing to accept some winter injury with reduced production, the following are suggested for trial plantings only.

French hybrid cultivars

Aurore **Zone 5a**

Vigorous vine with long cylindrical fruit clusters. Medium-sized berries turn golden color with pink blush when fully mature. Moderately productive. Very susceptible to black rot and powdery mildew. Ripens early September. Spur prune.

Foch **Zone 4b**

The leading red wine grape for commercial growers. Very vigorous and productive. Black fruited, small clusters with small berries. Moderately hardy. Ripens mid-September. Cane prune.

Leon Millot **Zone 4b**

Vigorous vines with adequate hardiness, similar to Foch. Develops a Burgundy-like bouquet with proper aging in the bottle. Cane prune.

Aris **Zone 5a**

Early ripening, white berry with a high sugar concentration (brix level). Excellent wine if cool fermented. Yields may be low. Cane prune.

Baco Noir **Zone 5a**

Vigorous plant, black fruited, long clusters with small berries. Moderately productive in limited trials. Very susceptible to black rot. Ripens mid-September. Spur prune.

Chancellor **Zone 5b**

Blue-black, medium-sized berries in medium to large, loose clusters. Yields similar to Concord. Makes excellent full-bodied red wine. Susceptible to downy mildew. Ripens late September. Spur prune.

Seyval Blanc **Zone 5b**

Large clusters of small, white berries. Moderately vigorous. Produces excellent dry wine. Resistant to some diseases. Ripens late September. Spur prune and cluster thin.



PLANTING STOCK AND PROPAGATION

Home gardeners and beginning commercial growers should purchase planting stock from reputable commercial nurseries or garden centers. Vigorous, well-rooted dormant plants are satisfactory. Occasionally, nurseries will have 2-year-old plants or potted plants for sale. These are also suitable and may produce more vigorous growth in the first season. But carefully consider any extra costs in buying older plants, especially if buying large quantities.

Grape cultivars, like other perennial fruits, must be propagated from vines since seedlings do not have the same characteristics as the parent plant. Layering or hardwood cuttings are the most common methods. It is illegal to propagate patented cultivars without permission.

If only a few plants are desired, layering is a satisfactory propagation method. In layering, select a 1-year-old cane near the vine base. Make a trench that is 4 to 5 inches deep. Lay the cane flat in the trench and cover at least two buds with soil. Cut off the tip, leaving two buds above the soil. Canes usually root well and can be cut from the parent vine, dug and transplanted early the next spring before growth begins.

For propagation by hardwood cuttings, select 1-year-old dormant canes late in winter. The best canes are live, green under the bark, undamaged, and $\frac{1}{4}$ to $\frac{3}{8}$ inch in diameter. Cuttings should have at least three buds spaced 4 to 6 inches apart. Bundle and store the canes in moist (not soggy) sawdust or sand. Keep the bundles in refrigerated storage (34° to 40°F) until needed. Cuttings of winter-tender cultivars should be collected in early November and stored through the winter in moist sand, peat, or sawdust.

Early in spring, set the cuttings 6 inches apart in well-drained, tilled soil in the nursery row. Set cuttings upright in a trench with the two lower buds covered and the top bud just above the soil surface. When planting, be sure to place the cutting so the buds that were nearest the trunk of

the vine are below the soil and the bud that was farthest away is above the soil. Press soil firmly around the cuttings and water to maintain adequate and consistent soil moisture levels. Plants should receive at least 1 inch of water weekly. Rooted cuttings can remain in the nursery row until transplanted to the permanent location before growth begins early the next spring.

An alternative to the trenching method described above is to lay down a sheet of black plastic. Cut holes into the plastic where you want to plant. Push cuttings through the holes and firm the soil. The plastic heats the soil and prevents weed competition. You'll need a soaker hose beneath the plastic to water the plants.

Dormant hardwood cuttings are also easily rooted in the greenhouse if planted in deep pots or tall paper cups as described above for field plantings. Pots or cups must have drain holes. Greenhouse-grown plants should be acclimated in an outdoor lath house or cold frame before transplanting to the field.

PLANTING DESIGN AND ROW SPACING

When possible, lay out the vineyard in straight rows which are easier to manage and reduce trellis costs. Rows longer than 500 feet pose trellis anchorage and support problems. On steeply sloping land, design rows to follow the grade or contour to help prevent soil erosion. Contact National Resource Conservation Service technicians in your county to assist in contour design for larger vineyards. If possible, arrange rows in a north-south orientation to allow maximum exposure to the sun.

Row spacing depends in part on the training and trellis system. In backyard plantings, 9 feet between rows is generally suitable. For larger plantings using conventional farm tractors, space rows at least 10 feet apart and leave 30 feet between the edge of the field and the beginning of the row.

For the umbrella kniffin or Geneva double curtain training systems, space plants in the row 9 feet apart. If using the single cordon system, space American grapes 12 to 14 feet apart in the row. These systems are described in the section on training and pruning.

PLANTING

Plants can be purchased either potted or as bare-root nursery stock. Bare root will be cheaper for large plantings. Potted plants are convenient for home gardens. Handle plants carefully to avoid damage or drying out. Set out plants as early as the soil can be worked without clumping.

Store dormant bare rootstock in moist sawdust in a cool location (32° to 40°F) until they can be planted. If this is not possible, heel in plants by digging a shallow trench on the north side of a building; place the plants in the trench and cover the roots completely with soil. Keep plants well watered. During planting, place bare roots in a bucket of water—but don't hold them in water for more than 8 hours. Prune off all but one vigorous cane and any broken and long roots. Spread the root mass in the hole and plant at the same depth as in the nursery. Fill around the roots with soil. Firm the soil and then water. Water newly planted vines every few days to keep the roots from drying.

Potted stock can be planted in the spring or summer. Make sure the soil in the pot does not dry out before planting. Plants are best held in a cool, shady location. Dig a hole slightly deeper and wider than the pot. Remove the pot and examine the root ball. If large roots are winding around the root ball make vertical cuts through the roots and spread them away from the trunk. Place the root ball in the hole. Fill the hole with soil and firm it around the plant, then water.

For either potted or bare root plants, insert a stake near the plant and loosely tie the vine in place. The stake will keep the trunk straight and train the vine upwards. Once the vine reaches the trellis the stake can be removed. See the section on training and pruning for more details.

SOIL MANAGEMENT AND WEED CONTROL

Vineyards planted on slopes have special soil management problems. Unprotected soils on slopes will erode easily. Using equipment in muddy soils is difficult. Maintain a permanent sod cover between the rows. Sod will hold the soil in place, support equipment, and reduce soil compaction. Perennial rye, red fescue, and Kentucky bluegrass are all suitable sod grasses for vineyards. The best time to establish the sod is the fall **BEFORE** planting. By doing so the sod will be established and will support traffic for spring planting. Mow the sod between the rows four to five times per year.

Grass and other vegetation should not be allowed to grow under the trellis or around the vines. Weeds compete with the vines for water and nutrients. Grasses are the most competitive weeds. Weeds in the row can be controlled with herbicides, cultivation, or mulching.

Several herbicides are registered for use on grapevines. Carefully read product labels before applying any herbicide to grapes. Don't use 2,4-D herbicides anywhere near grapevines as it can cause flower abortion and misshapen foliage. Avoid using herbicides the first year after grapevines are planted.

Special cultivators called grape hoes can be used under the trellis to manage vegetation. This equipment leaves some vegetation around the trunk that will have to be hand hoed for complete control.

For small plantings cultivating to a depth of 1 to 2 inches with a sharp hoe or shovel will help keep weeds down. Or mulch can be used to control weeds. Organic materials such as straw, hay, sawdust, shavings, or wood chips are acceptable for mulching. Some weed barrier fabrics when covered with a thin layer of mulch will also limit weed growth. Apply mulches in a doughnut fashion around the vines. Don't mound the mulch around the trunk.

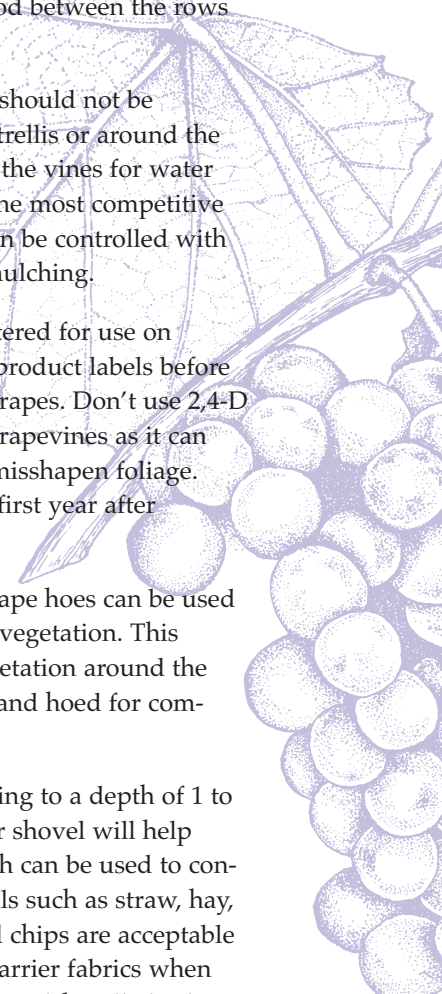

FERTILIZATION

As noted previously, a soil test before planting is important to determine soil pH and nutrient needs. Lime, phosphorus, and potassium do not move readily through the soil. If the soil is tested the summer or fall before planting, you can apply and till needed nutrients into the soil during the fall. This saves time in the spring by reducing the need for preplanting soil preparation.

While grapes grow successfully over a wide range of soil pH, a soil pH of 6 to 7 is optimal for soil nutrient availability. Where a soil test indicates a need for lime, apply only the suggested amount and incorporate it into the soil. Repeat soil tests at least every three years to monitor changes in pH or nutrient availability.

Nitrogen is normally needed annually. All forms of nitrogen fertilizers currently available in Wisconsin are satisfactory for grapes. On soils with a pH above 7.0, ammonium sulfate or urea is preferred. Apply 20 to 25 pounds of nitrogen fertilizer per acre to vineyards in the spring after the soil thaws and before growth begins.

Before applying additional nitrogen in mid-June, assess damage to the vines. If vines were injured during winter or if the blossoms were killed by frost, do not apply any more nitrogen fertilizer. If winter injury is minimal and fruit are developing, apply 20 to 25 pounds of nitrogen per acre. Two applications at lower rates permit some control of vegetative growth which is likely to be excessive following winter injury or fruit crop loss.

Grapes rarely need micronutrient fertilizers in Wisconsin. If you suspect a micronutrient deficiency, submit a sample for foliar analysis to verify a need before applying the fertilizers.

County Extension offices throughout Wisconsin have instructions for taking and submitting soil and foliar samples to suitable laboratories.

FLOWERING AND FRUIT SET

Grapes are self-fruitful so blocks of a single cultivar may be planted. Grape flowers are not showy and insects are not required for pollination.

Grapevines typically set more fruit than they can fully support. Training and pruning systems are designed to optimize crop load. In some cases it may be necessary to thin the clusters to maximize fruit quality.

Cluster thinning is used to eliminate excess and small fruit clusters. Benefits include higher berry sugar levels, earlier ripening, and improved winter hardiness by preventing excess stress on the vine. If properly done, cluster-thinned vines have nearly equal yields of non-thinned vines. Cluster thinning is typically most effective on cultivars with large berry clusters like Swenson Red, Seyval and Edelweiss, and least effective on small-clustered wine cultivars like Foch and Millot. Remove clusters nearest the shoot tips and also the smallest clusters about 1 week prior to bloom. Usually only one or two clusters are retained per shoot. If a vine has 40 fruiting shoots, keep 40 to 80 clusters.

HARVESTING AND STORAGE

Grapes change to their mature color long before they are ready to harvest. The fruit does not continue to ripen after harvest, so harvesting early will hurt quality. The best way to check for maturity of grapes is to taste the berries periodically. The proper stage for harvest depends on how you intend to use the fruit. Fruit that will be used fresh or in juice or jelly should be left on the vines until the flavor is sweet and full. Fruit that will be made into wine may be harvested somewhat earlier while the acid content is higher.

Once harvested, grapes can be stored for 1 to 2 months at 34°F. Grape quality declines over time in storage. The best quality products will be made shortly after harvest. To store grapes for later use, place them in vented plastic bags in a refrigerator. Most refrigerators can only maintain

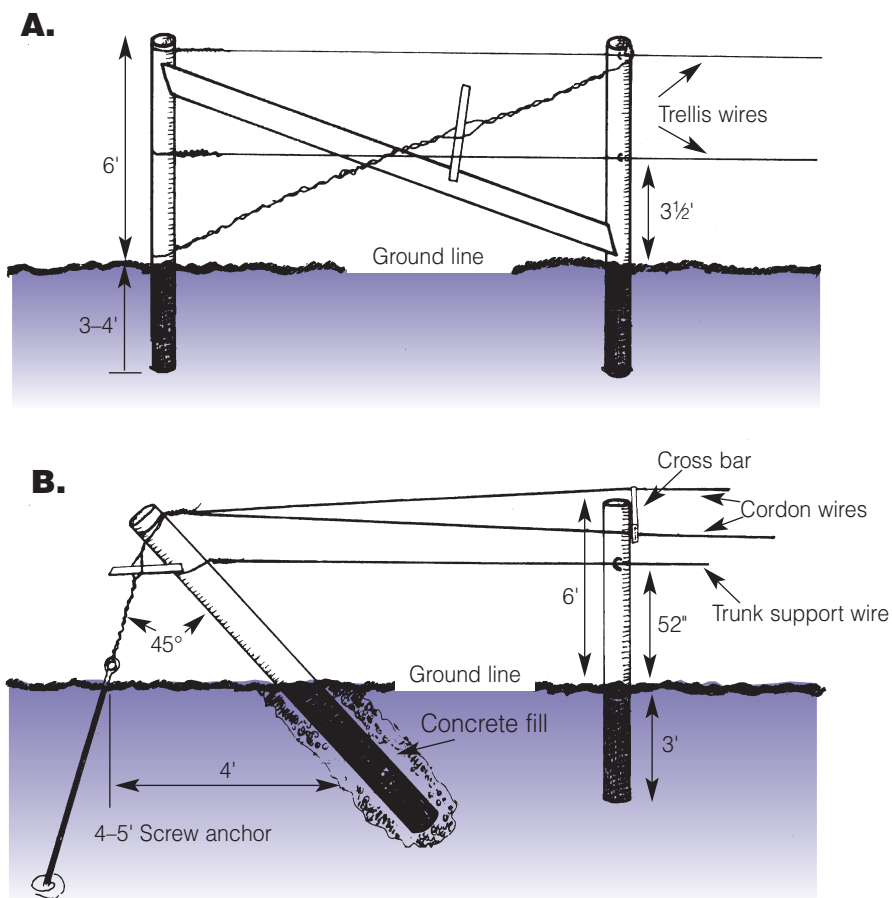

FIGURE 2.
Two common methods for bracing vineyard trellis end posts. **A** is satisfactory for single cordon or umbrella kniffin training systems. **B** is preferred for Geneva double curtain training system.

40°F, while the best storage temperature for fruit is 32° to 34°F. Don't wash the fruit before storage as the water can spread diseases and it is difficult to dry berries on the cluster interior.

TRELLIS CONSTRUCTION

Grape trellis construction is similar to farm fence construction, but grape growers must be especially careful to allow for adequate bracing and trellis strength since vines and fruit create severe loads which increase with strong winds.

Construct trellises during the first growing season or prior to growth the following spring so that vines can be trained early.

End posts should be larger than line posts. Use preservative-treated posts that are 9 feet long and 6 inches thick. Other suitable materials include

concrete posts or railroad ties. Set end posts at least 3 feet deep and leaning slightly away from the line posts (direction of wire tension). Top wires for most trellises should be at least 6 feet above the soil for maximum light exposure of canopy leaves. If you'll be training winter tender varieties using the J-system or spur-pruned rose system, trellises only need to be 4 feet tall. Figure 2 shows two common bracing methods.

Use treated line posts that are 8 to 9 feet long and 3 inches thick. Set the posts 24 to 36 inches deep and 20 to 24 feet apart in the row depending on vine spacing.

For the umbrella kniffin or other kniffin and the single cordon training systems, number 9 galvanized wire or the newer high-tensile steel wire is preferred for the top wire. Number 10 or number 11 wire is suitable for lower wires. Avoid using

FIGURE 3. Alternative methods for adjusting and maintaining grape trellis wire tension.

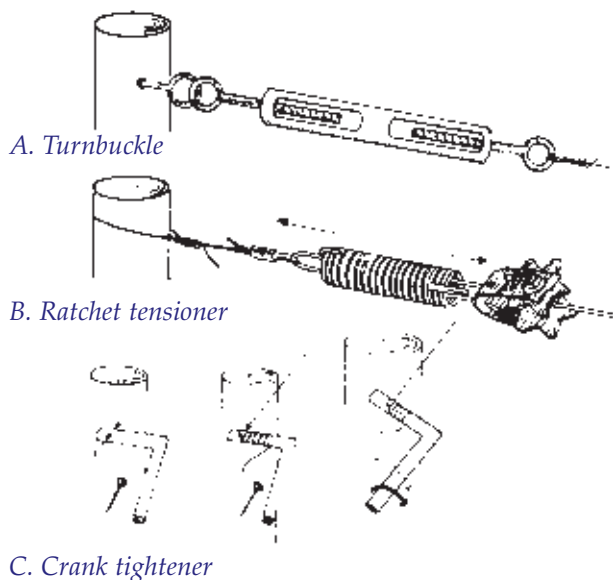

large diameter plastic strand (monofilament) as it does not provide adequate support for conventional grape trellises.

The wire attachment to end posts should provide a way to adjust wire tension. Since wires contract in winter and may damage the trellis, loosen the wires in fall. In spring, tighten wires after pruning but before tying the vines to wires.

For small home plantings, relatively inexpensive 10- to 12-inch-long heavy-duty turnbuckles, available from hardware or farm supply stores, are slow but effective aids to adjust wire tension (figure 3). Owners of larger vineyards should buy cinching or cranking devices which can rapidly adjust wire tension.

To help move equipment and transport fruit at harvest, limit trellis rows to 300 feet in length. Trafficways between trellis spans should be wide enough to allow tractors or other equipment to turn into adjacent rows.

CANE VS. SPUR PRUNING

Different types of grapes have different fruiting habits and are, therefore, trained and pruned differently. American grapes typically produce fruit at the second to the fifth cane nodes. Such vines should be cane pruned to leave fewer, longer canes. When cane pruning vines you should also leave renewal spurs among the canes. These spurs will produce fruitful growth for the following year. European and French hybrids typically produce fruit on the second and third cane nodes. These vines should be spur pruned leaving a greater number of short canes (spurs). Refer to the cultivar list (page 4) for direction on which cultivars should be cane or spur pruned.

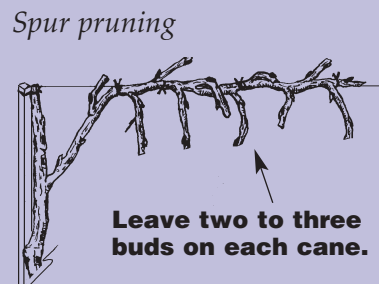
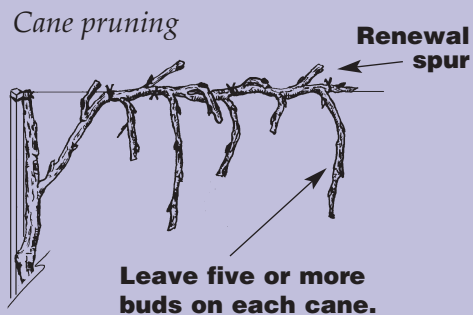

TRAINING AND PRUNING

A training and pruning system should be chosen before the vines are planted for proper spacing and to build the trellis system. Criteria to consider when choosing a system are type of vines planted, space available, and the expertise of the grower.

The single cordon, umbrella kniffin, and Geneva double curtain training systems are well suited for Wisconsin. The J-system and spur-pruned rose system are good choices if growing grapes that aren't fully winter hardy for your area. All of these systems are easy to use and allow good light penetration to the leaf canopy. The illustrations and text on the following pages show how to establish, train, and prune these systems.

Vine establishment

First year

After planting vines and before any growth, cut off the remaining cane leaving two buds above the soil surface.

If trellis wires are in place, tie twine to a stake driven in near each vine and stretch it vertically to the wire directly above the vine, or drive scrap lumber stakes 4 to 5 feet in length into the soil near the vine. Tie new growth to the twine or stake. Keep the ties loose to prevent new shoots from being girdled by the tie.

Second year

To prevent delay and lost production, decide which training system to use and install the appropriate trellis before the second season.

During second-season dormant pruning, choose one or two straight canes for the permanent vine trunk and tie the cane tip tightly to the uppermost wire it will reach.

VINE ESTABLISHMENT

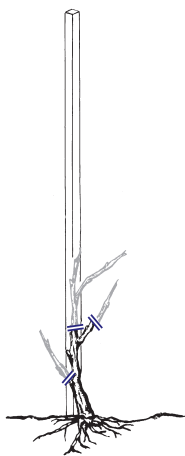

First year

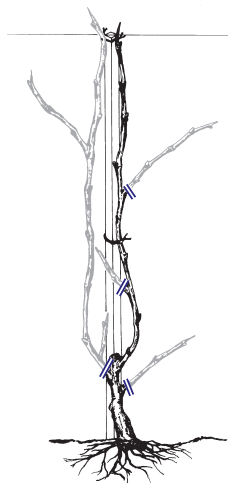

Second year

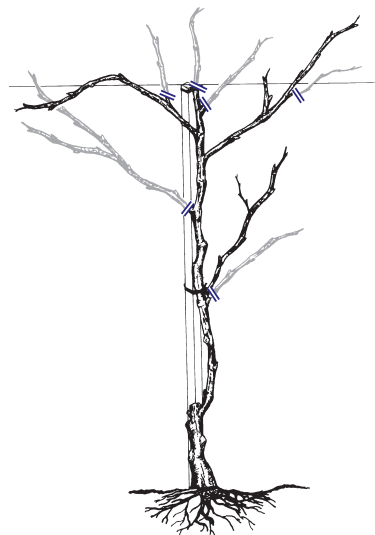

Third year

Third and succeeding years

While proper pruning and training might seem excessive to the novice, growers should yearly trim all but a fraction of the several hundred buds on a mature healthy grape vine to leave a proper balance of fruiting wood to vine growth for maximum production of high quality fruit.

Leaving all of the buds on the vine lets the plant overproduce; the vine expends most of its energy in excessive vegetative growth. Unpruned grape vines produce small berries, have delayed fruit ripening, and produce weak unproductive wood for the following season.

For vigorous American grapes, 50 to 60 buds will usually produce crops of 16 to 20 pounds per vine or 5 to 6 tons of fruit per acre.

Single cordon

Training system. The single cordon system is the simplest training and pruning system. It is particularly well suited for European or French hybrid grapes but also works for American grapes. Vines may be either spur or cane pruned.

Staple a single wire to the top of vertical posts for maximum strength and support. The wire should be about 6 feet above the soil. Space plants 12 to 14 feet apart to allow for vigorous growth.

Pruning technique. Train a single cordon to the wire. Loosely tie young canes to the wires, extending the cordons 6 to 8 feet in opposite directions. To reduce cordon sagging, wrap young canes several times around the wire and tie tightly to the cordon end.

Once cordons are established, select 10 to 12 downward growing new fruiting canes close to the trunk and prune all excess new canes and all old fruiting canes. Cut the selected canes to four to six buds each, following the procedures described in the balanced pruning section.

Leave renewal spurs on the cordon to produce canes for the following year.

SINGLE CORDON

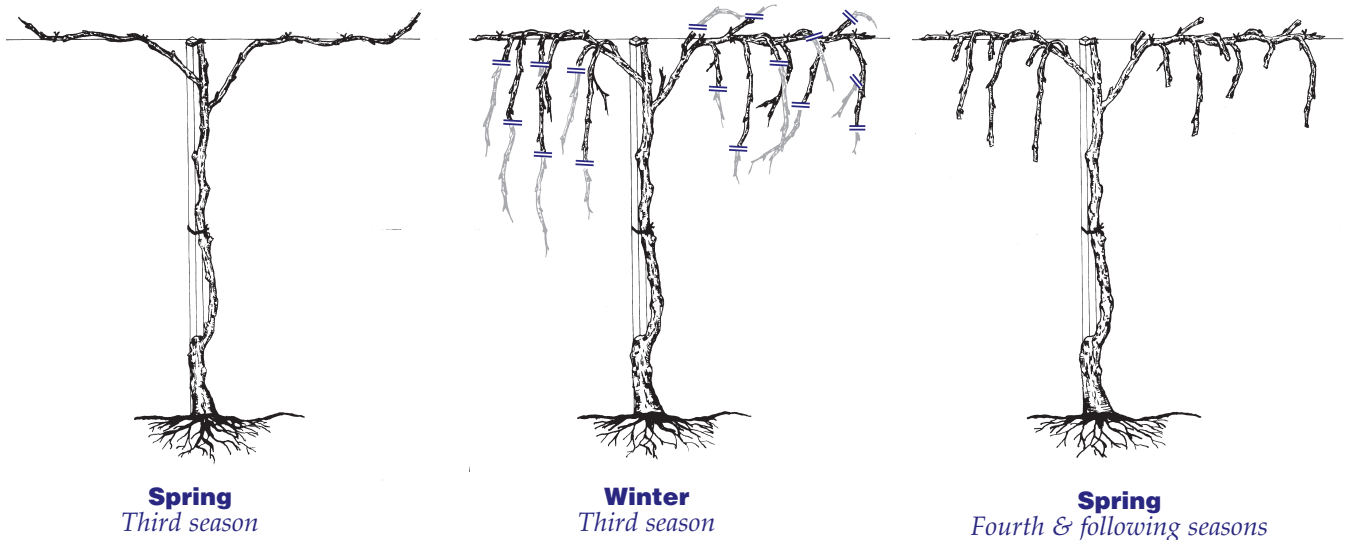

Umbrella kniffin

Training system. The umbrella kniffin system is well suited to American grapes. In this system the vines are head trained and cane pruned. The trellis consists of two wires, one at 5½ to 6 feet and the second at 3 feet from the soil surface.

Pruning technique. Train the single trunk to 4 to 6 inches below the top wire. Canes and renewal spurs originate from the head and are drooped over the top wire.

Each dormant season, cut old fruiting canes from the head. Retain two to six fruiting canes; four canes are most common. Each cane should have 10 to 15 buds.

Bend the remaining canes sharply over the top wire and tie tips tightly to the lower wire. Spread canes to use all the space available.

Leave four to six renewal spurs (two buds each) at the vine head to produce the following season's fruiting cane. Keep fruiting wood and renewal spurs at the head to maintain the system.

Geneva double curtain

Training system. The Geneva double curtain (GDC) system is designed for machine harvesting, but is suitable for hand harvesting. This system is cordon trained and may be either spur or cane pruned. Any grapes can be trained to the GDC, but it is ideal for vigorous American grapes. The vigorous growth is trained into offset canopies to allow maximum light exposure. The GDC is a more complex system with a more expensive trellis and requires more expertise to implement. Only completely winter hardy cultivars should be trained to this system. If vines are winter injured then significant structure must be regrown.

Attach the trellis wire to the posts, 4½ feet above the soil. This wire will support the trunks. To create the trellis arms, nail a sturdy board (1 inch thick, 6 inches wide, and 4 feet long) at the top of each post. Attach cordon wires at each end of the trellis arms. These wires will support the cordons, or arms. In a row of grape vines, trunks are trained alternately to the left or right cordon wire.

UMBRELLA KNIFFIN

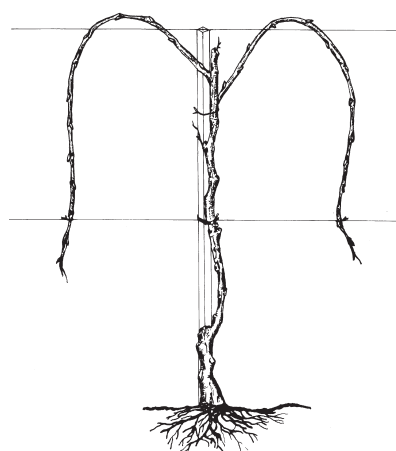

Spring
Third season

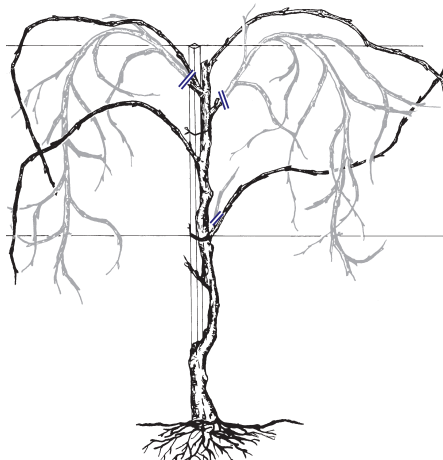

Winter
Third season

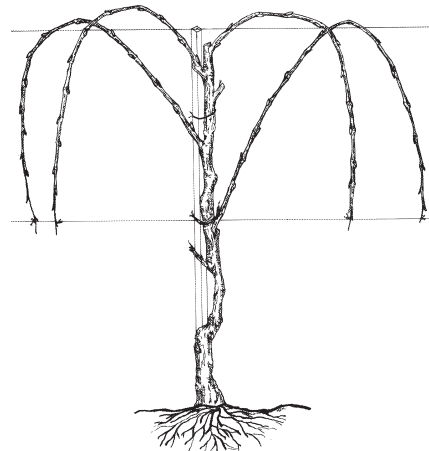

Spring
Fourth & following seasons

GENEVA DOUBLE CURTAIN

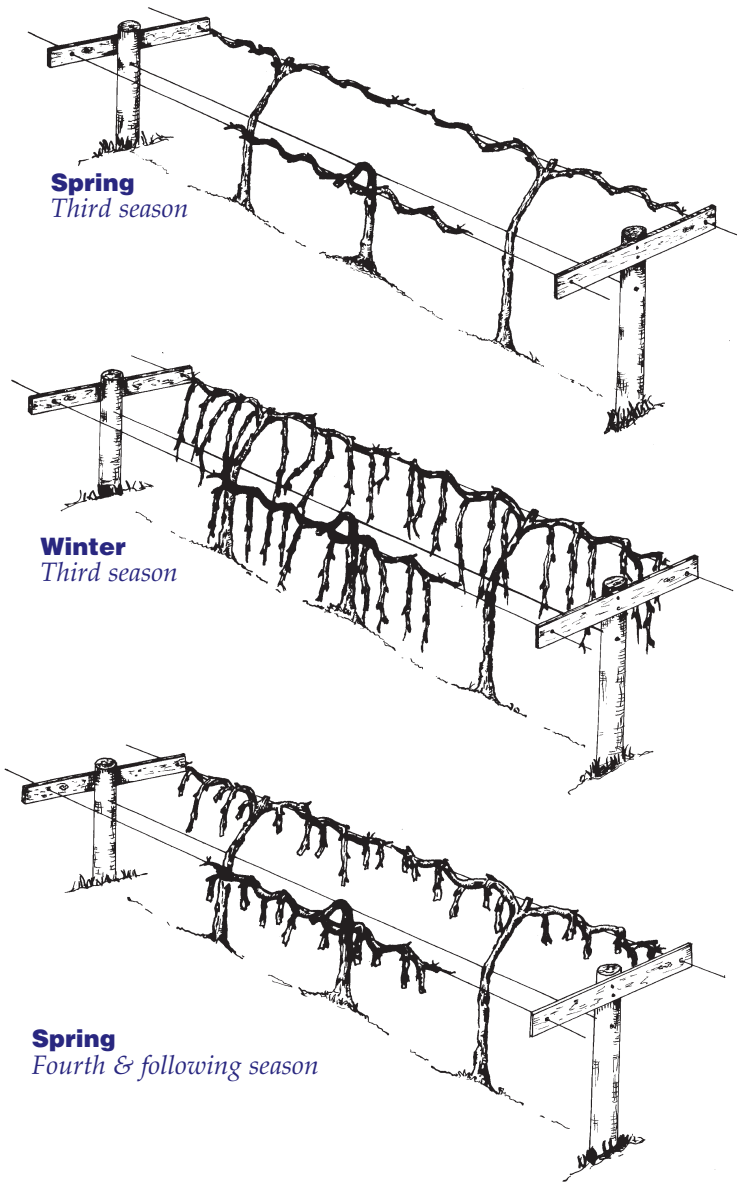

Pruning technique. In the Geneva double curtain system, retain short fruiting canes (four to six buds each) on permanent arms or cordons. When establishing cordons after the initial planting year, loosely tie young canes to the wires extending the cordons 6 to 8 feet in opposite directions. To reduce cordon sagging, wrap young canes several times around the wire and tie tightly to the cordon end.

Once cordons are established, select 10 to 12 downward or outward growing new fruiting canes close to the cordon and prune all excess new canes and all old fruiting canes. Cut the selected canes to four to six buds each, following the procedures described in the balanced pruning section below.

Leave renewal spurs on the cordon to produce canes for the following year.

Balanced pruning

Individual grape vines vary in vigor and productivity. Balanced pruning will improve yields, fruit quantity and quality, maximize each vine's exposure to sunlight, minimize excessive growth, and maintain good vine vigor.

For most American grapes, follow the 30 plus 10 system. Retain 30 fruiting buds for the first pound of prunings plus 10 buds for each additional pound. For a vine with 3 pounds of prunings, retain 50 fruiting buds. Do not count renewal spur buds. For French hybrids, follow the 20 plus 10 system. Retain 20 fruiting buds for the first pound of prunings plus 10 buds for each additional pounds. Retain a maximum of 40 to 50 buds.

For example, in using the umbrella kniffin system remove all but five or six fruiting canes, also leaving six to eight renewal spurs with two buds each arising from the head. Weigh the prunings and determine the total bud number needed. Cut off additional fruiting canes and cut tips of remaining canes to reach the desired bud total. After several weighings, you should be able to estimate the number of buds to leave without further weighing.

Pruning disposal

For very small vineyards or home plantings, cut, bundle and remove the prunings. For larger plantings, prunings may be chopped with a flail mower or power mulcher and left in the vineyard for mulch.

MANAGING GRAPEVINES IN COLD CLIMATES

If planting grape cultivars that are not fully hardy in Wisconsin or if growing hardy cultivars in areas with severe winters, there are some cultural techniques that will increase your chances for successful grape production. These practices are more labor intensive than the systems previously described and will likely be unprofitable for large-scale grape production. However, they do allow a wider selection of cultivars for small plantings.

If using straw mulch to protect vines, you must bait for rodents. A wax brick bait containing zinc phosphide works well. Place bait around the outer edge of the planting. Reduce rodent habitat by mowing the vineyard and surrounding areas in the fall.

Training and protecting winter-tender vines

J-system

This system produces angled trunks that are less likely to crack or break when removed from the trellis each winter.

At planting, place the vine at a 30° to 45° angle. Pin new growth to the ground. Once the vine is 24 inches long, tie it to a flexible support and train it onto the lowest trellis wire. During the next 2 years the trunk becomes fully established.

The actual training and pruning system used depends on the cultivar. The vines are headed (pruned off) at the bottom trellis wire at 12 to 18 inches above the ground. This forces new cane growth at that point. These canes will form the permanent structure of the vine. Spread the canes across the trellis in fan fashion.

As soon as the leaves drop in the fall, prune the vines and remove the plant from the trellis. Pin the plant to the ground using wire hoops. If using soil cover the vines with at least 3 inches of soil in late October or early November before the soil freezes. If using straw, wait until the

J-SYSTEM

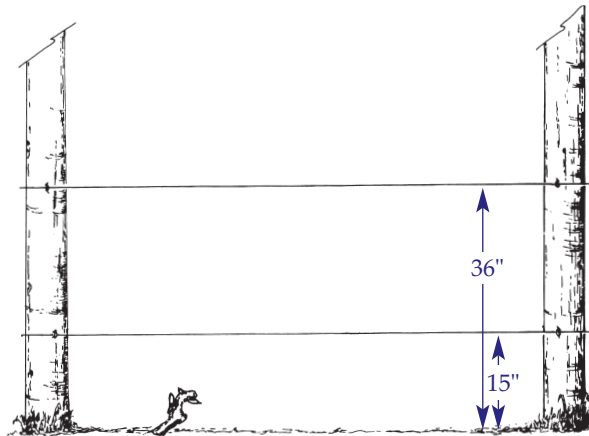

At planting

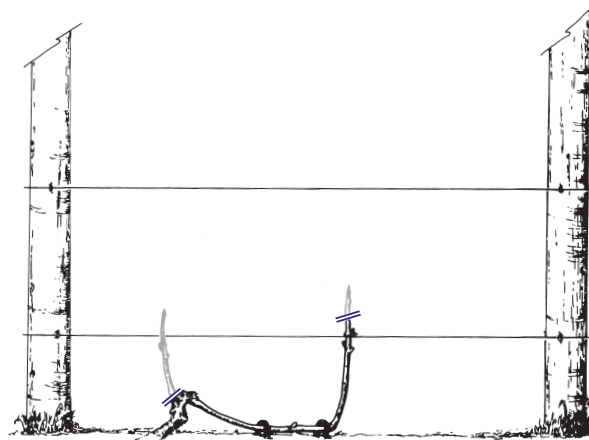

First year

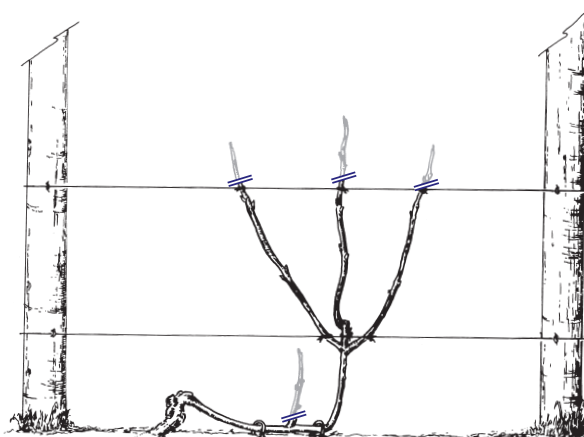

Second year

ground is frozen to a depth of 1 to 2 inches; cover plants before temperatures fall below 20°F, even if the soil isn't yet frozen. Mulch to a depth of 3 to 4 inches. This is equivalent to about one bale of straw (30 to 45 pounds) between trellis posts. Straw should be clean and free of weed and grain seed. In the spring, uncover the vines and place them back on the trellis by mid-April or before budbreak.

Spur-pruned rose

The spur-pruned rose system keeps the trunk short, so hay or soil can be mounded around it for easy winter protection. However, the plant grows closer to the ground, making harvest less convenient. This system works well with spur-pruned cultivars like Aurore, Chancellor, and Seyval Blanc. Use two or three trellis wires placed 15 and 36 inches above the ground to support the vines. The number of wires needed depends on the vigor of the vine. As young canes grow in the spring, spread them out in a fan shape to maximize light exposure. In early winter, prune back multiple short canes or spurs. Mound straw around each trunk before temperatures fall below 20°F. Remove the straw in early spring before budbreak or by mid-April.

INSECT PESTS

Although widespread major insect problems on grapes are relatively rare in Wisconsin, localized pest problems require prompt and thorough attention. The key to controlling grape insect pests is to frequently examine plants for signs of pest activity and apply controls before the vine, leaves, or fruit are seriously injured. Grape growers should learn to recognize the most common insect problems in this state. For more information on controlling pests or diseases, check Extension publication *Grape Pest Management for Home Gardeners* (A2129).

Grape berry moth

Grape berry moth is probably the most important grape pest in Wisconsin. The damaging stage is a greenish to purple larva (worm) which is about $\frac{3}{8}$ inch when full-grown. The insect overwinters on the ground in a cocoon formed the previous year. In late May to early June, the mottled brown adult moth, $\frac{1}{4}$ to $\frac{3}{8}$ inch in length, lays eggs on the clusters of flowers or small fruit. Usually the larvae spin noticeable webbing on the flower or fruit cluster where they are feeding. In July the fully grown larva forms a small leaf flap which it then folds around its body. These cocoons may remain on the leaves or may fall to

SPUR-PRUNED ROSE

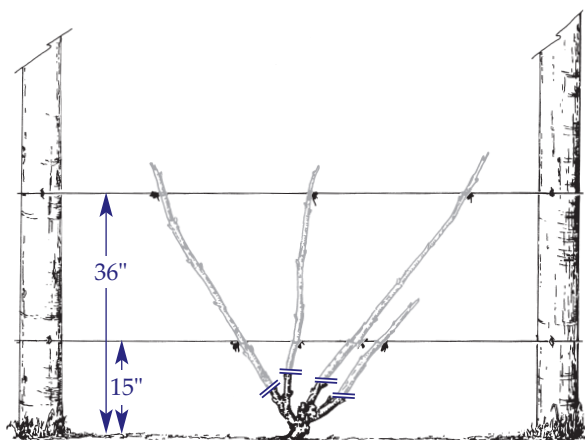

Third year

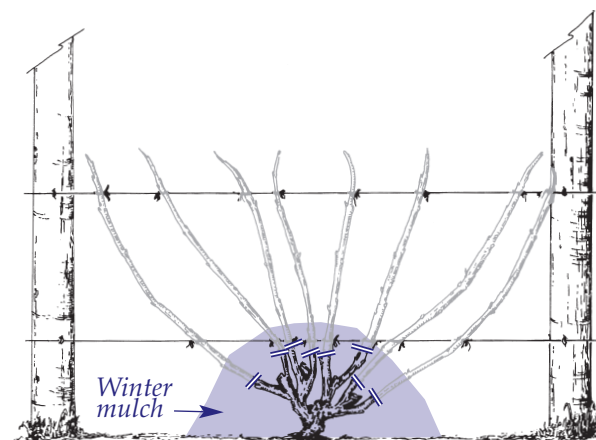

Subsequent years

Grape berry moth adult, larva, and cocoons



the ground. The one to two additional generations in the summer feed by tunneling through the fruit. Each larva can feed on three or more berries, causing them to shrivel or drop. The last generation larvae fall to the ground and form overwintering cocoons from leaf debris under the vines.

Where grape berry moth has been a problem, examine flower clusters for webbing and small larvae starting about 5 days before first bloom. If larvae are found, apply an approved insecticide. Immediately after bloom, inspect fruit clusters for webbing, damaged berries and larvae. Begin weekly inspections for summer generation injury in early August. Commercially available pheromone traps can be used as an aid for monitoring adult flight and egg-laying periods.

Grape leafhoppers

Several species of leafhoppers attack grape foliage. Adults are wedge-shaped, active insects, about $\frac{1}{8}$ inch long, usually whitish to pale yellow with yellow or orange markings. Both adult and immature stages feed by sucking juices from the leaves. They usually feed from the lower leaf surface, primarily on younger foliage. Leaves first turn speckled white, then take on a pale, blotchy appearance. If infestations are large enough, the leaves will turn brown and fall from the vines. Leaf injury will reduce vine growth and may interfere with berry ripening. To monitor for leafhoppers, examine the undersides of leaves for the small, active insects and their white cast skins.



Adult leafhoppers overwinter under leaves on the vineyard floor or in adjacent protected locations such as brush piles or fence rows. They

return to the vines in spring to feed and lay eggs. The population is continuous through the growing season, with probably two generations per year in Wisconsin.

Control leafhoppers if populations are large enough to discolor leaves. The first application may be as early as post-bloom. Otherwise, control as needed during the summer months.

Grape flea beetle

Both adult and larval stages of grape flea beetle injure plantings. The adult beetle is about $\frac{1}{4}$ inch long, somewhat oval, and a dark metallic blue-black color. It overwinters in the leaf litter below the vines or in adjacent protected locations such as brush piles and fence rows. It flies to vines on warm sunny days in early spring at about the time primary buds are beginning to develop. It tunnels into these developing buds, preventing cane development. By the time the buds are about $\frac{1}{2}$ inch long with some leaf development, the beetles start feeding on the developing leaves, resulting in distorted leaves with holes. During this time the adults are laying eggs on vines. The eggs hatch into caterpillar-like larvae which feed on the upper leaf surface producing dead brown spots and holes. When about $\frac{1}{4}$ inch long, the full-grown larvae drop from the leaves and pupate in the soil. There may be a partial second generation in Wisconsin.



Monitor for adults on warm spring days around budbreak. If you see the beetles, apply approved chemicals. Larvae are usually controlled by sprays aimed at grape berry moth; otherwise control as needed.

Cutworms

Cutworms occasionally cause serious damage early in the season by cutting off the new developing canes. Damage is usually more common in weedy areas, and weed control reduces the likelihood of cutworm injury. If cutworms are a problem, use an approved cutworm bait.



Grape phylloxera



Grape phylloxera is a tiny aphid-like insect that causes small round growths on the foliage. These growths, called galls, are not injurious when they are few in number. To control, apply an approved spray at the first sign of gall formation. Grape phylloxera also attacks the roots of some grapes, causing root galls. European varieties on their own rootstock are most susceptible to attack. Most grapevines sold today are grafted onto resistant native rootstock which is not damaged by phylloxera.

Japanese beetle



Japanese beetle is a relatively recent invader of Wisconsin. The $\frac{1}{3}$ inch beetles are reddish brown and metallic green, with a series of white tufts of hair around the edge of the wing covers. They feed on many types of trees and shrubs, including grape plants, from late June to early August. Populations can build to very large numbers, resulting in substantial defoliation. The beetles are strong fliers and can invade from considerable distances. Modest defoliation will not affect mature grape plants or yield, but defoliation over 10%, especially after the young grapes begin to form, can decrease yield. Substantial defoliation to young plants will delay their establishment. Beetles usually do not feed directly on the fruit.

Many insecticides registered for use in grape production will kill Japanese beetle adults, but others may soon fly in. Traps can catch thousands of beetles, but, because they can attract more beetles than they catch, research has shown that their use can actually increase damage to small gardens. If using traps, place them at least 50 feet away from plants you wish to protect. If you have a small planting, you may find success using the woven fabric "floating row covers" that are available to protect garden plants from flying insects.

Rose chafer

The rose chafer adult is a light brown beetle about $\frac{5}{8}$ inch in length with long slender legs. This is the damaging stage. The beetles fly into the vineyard from surrounding grassy areas and feed on foliage, blossoms and developing fruit. They are a more serious problem in areas of sandy soil, where the grub-like larvae feed on the roots of grasses.



Although readily killed with approved insecticides, rose chafers can do considerable damage in areas where they are abundant, by continuous immigration into the vineyard. The flight period usually persists for only 1 to 2 weeks, but two to three insecticide applications may be needed during this time. Home growers with small plantings can cover the vines with cheese cloth or floating row covers during this period. Coverage should be completely to the ground. For more information on rose chafer, consult Extension publication *Deciduous Tree and Shrub Disorder: Skeletonizing by Rose Chafer* (A3122).

Spider mites

Spider mites occasionally can damage foliage during prolonged periods of warm, dry weather. Spider mites are extremely small, measuring about $\frac{1}{32}$ of an inch. Color varies from pale yellow to red. They feed on the undersides of leaves in a fine network of webbing. Feeding can cause the leaves to yellow and wither, reducing vine vigor and interfering with berry ripening. Treat with an approved miticide when needed.



DISEASES

Only a few diseases cause significant economic damage to grapes grown in Wisconsin. Most of these are caused by fungi, although some are caused by bacteria and viruses. Black rot and downy mildew usually cause the most damage. If not managed, diseases can reduce yields and affect the quality of juice and wine.

Effective, consistent disease management is essential for long-term productivity. The best approach integrates planting resistant cultivars, following cultural practices that discourage disease development, and applying chemicals only when necessary to avoid serious damage. Effective disease management begins with accurate diagnosis. For assistance identifying a disease or to confirm your diagnosis, contact your county Extension office.

Resistant cultivars. Grape cultivars vary in relative resistance to the different diseases. Unfortunately, many of the most desirable cultivars are susceptible to one or more important diseases. Select cultivars adapted to your region, choosing varieties that are least susceptible to diseases known to be a problem in your area.

Cultural practices. The following cultural practices help limit disease development.

- Plant only certified, virus-free vines obtained from a reliable nursery. Diseases caused by viruses cannot be controlled once established, so they must be kept out from the beginning.
- Select a site, orient rows, and prune vines to maximize air circulation and promote drying in the canopy since infection by fungi and bacteria often requires plant surfaces to be wet for prolonged periods.
- Eliminate diseased plants or plant parts, which may be a source of contamination for the remaining healthy plants.
- Destroy wild or abandoned grapevines near vineyards as these may be reservoirs for pathogens (particularly viruses).
- Do not fertilize excessively with nitrogen. This produces dense growth that dries slowly.

Chemical control. The use of fungicides to control certain diseases—especially black rot and downy mildew—will be necessary in most years to maintain a quality vineyard and consistent fruit production. However, registration and availability of fungicides can change unexpectedly.

For information on currently registered chemicals, consult Extension publication *Grape Pest Management for Home Gardeners* (A2129), or contact your county Extension office.

Black rot

Black rot is one of the most economically important diseases affecting grapes grown in the Midwest and in the eastern part of the country. Both the grapevines and the fungus that causes this disease are native to North America; therefore, the disease usually is present wherever grapes are grown. In wet weather, black rot can cause devastating losses if not controlled.

Symptoms. All succulent new growth, including leaves, shoots, tendrils, and berries, is susceptible to infection. However, leaves that have been expanded for more than 1 week and ripe fruit are not susceptible. Symptoms first appear on leaves and stems. Lesions become evident on leaves about 1 to 2 weeks after infection, appearing as tan, circular- to irregular-shaped spots. These spots are often surrounded by narrow, dark-colored borders. Tiny, black fruiting bodies of the fungus (called pycnidia) usually are visible just inside the margins of lesions. Lesions can girdle leaf petioles, killing leaves. Lesions on stems and tendrils appear as elliptical, sunken, black cankers, which can be up to 1 inch long. On berries, lesions first appear as small, white spots with red-brown margins. Berries then turn brown. They eventually shrivel, turn black, and become spotted with pycnidia. These shriveled berries are known as mummies.

Disease cycle. The fungus overwinters in lesions on stems and tendrils or in mummies that remain attached to the vines or fall to the ground. Infection first occurs in the spring just after bud-break. Rain or dew triggers perithecia (another type of fruiting body) to eject spores. The spores land on succulent green tissues and cause infection when water is present on plant surfaces for prolonged periods. Six to nine hours of leaf wetting is required for infection when temperatures are 60° to 85°F. At higher or lower temperatures, longer wetting periods are required. Pycnidia

develop in infected tissues and produce additional spores throughout the season. These spores are spread by splashing rain and cause new infections.

Disease management. American grape cultivars tend to be more resistant than French hybrid cultivars, although they both vary considerably in susceptibility. Highly susceptible cultivars include Aurore, Baco Noir, Canadice, Catawba, Concord, Niagara, and Reliance. Foch, Fredonia, Himrod, and Maréchal Foch are moderately susceptible while Delaware and Vignoles are less susceptible. Follow the cultural practices described earlier to help limit disease development. To prevent new infections, remove mummies in the fall or before budbreak in the spring. It is especially important to remove mummies that are left hanging on the vines; these can release spores throughout the growing season. In addition, timely applications of fungicides are necessary in most years to avoid serious damage.

Downy mildew

Downy mildew, like black rot, is native to North America and occurs in most regions of the Midwest. It thrives in warm (55° to 85°F), wet weather and can cause serious crop loss. Also, the disease can cause early defoliation which delays ripening and increases susceptibility to winter injury. The disease tends to be more severe and difficult to manage in southern than in northern Wisconsin, with the greatest damage occurring in August and September.

Symptoms. On leaves, lesions appear as chlorotic, yellowish areas on the upper surface with corresponding areas on the lower surface covered with white, downy growth of the fungus. Lesions on the upper surface may turn brown and coalesce. If older leaves are attacked later in the summer, look for a mosaic pattern of small, yellow and red-brown angular lesions. Infected shoots, tendrils, and leaf or fruit cluster stems become distorted, swollen, or curled and often are covered with masses of white spores. Eventually, these parts of the plant turn brown,

wither, and die. Young berries are very susceptible. Infected berries discolor, shrivel, and fall off easily. During periods of high humidity, white spores may cover berries. The fruit becomes less susceptible with age; however, infection can move into the berries from diseased stems. Infected older berries usually are conspicuous (remaining firm and turning dull green to red-purple) but may drop from the cluster.

Disease cycle. The fungus overwinters in infected leaves that have fallen to the ground. In the spring, rain splashes spores from infected leaves to new growth. The fungus can attack all green, actively growing parts of the plant that have functional stomata (pores for air and gas exchange), particularly leaves. Additional spores are produced on newly infected tissues and are spread by both wind and rain. At temperatures above 75°F, infection occurs when plant surfaces are wet for as little as 2 hours. When the temperature drops below 45°F, the fungus requires 9 hours of wetness. Symptoms usually appear 1 to 2 weeks after infection.

Disease management. American grape cultivars tend to be more resistant than French hybrid cultivars. Catawba, Fredonia, Niagara, and Reliance are most susceptible. Aurore, Baco Noir, Canadice, Concord, Foch, Himrod, and Maréchal Foch are less susceptible. Follow recommended cultural practices listed earlier to help limit disease development. In the spring before budbreak, either bury infected leaves by cultivating around the vines or remove them altogether. In addition, timely applications of fungicides are sometimes necessary to avoid crop loss, particularly on susceptible cultivars and when wet weather persists.

Phomopsis cane and leaf spot

This disease previously was called “dead arm,” a problem that now is known to be two separate diseases—Phomopsis cane and leaf spot and Eutypa dieback. Phomopsis cane and leaf spot, which is caused by a fungus, is most likely to occur when wet weather persists after budbreak. It occurs only sporadically in Wisconsin and

more frequently in the southern part of the state. The disease weakens vines and makes them more susceptible to winter injury. Only under severe disease pressure are fruit infected.

Symptoms. Only young, green tissues are infected; shoots longer than 8 inches are not susceptible. Consequently, the disease is particularly a problem when cool, wet periods follow immediately after budbreak. Symptoms usually appear 3 to 4 weeks after infection. Sunken, black, elliptical lesions on shoots (including tendrils) are the most obvious symptom and occur most frequently on lower portions of green stems. These lesions may coalesce to form a dark encrusted region; severely infected stems may split lengthwise. Infections on stems of leaves and fruit clusters are similar to those on shoots and can result in girdling, which may cause leaf drop and shriveling of berries. Lesions on leaves initially appear small, light green, and irregular in shape, later turning black with yellow margins. Leaves with many lesions may turn yellow, be misshapen, and drop from the plant. Lesions may be concentrated along veins, giving leaves a black and puckered appearance. Usually only lower leaves are affected. The fungus also can attack the berries and cause a fruit rot, but this is not common in Wisconsin. Infected berries are light brown, easily drop from the cluster, and eventually shrivel and dry into mummies. These mummies can be confused with those caused by black rot.

Disease cycle. The fungus overwinters in lesions on 1- to 3-year-old wood where tiny, black fruiting bodies of the fungus (called pycnidia) eventually develop. In the spring, spores are released and dispersed during periods of rain. The fungus is inactive during the warm, dry months of summer, but may become active again in the fall as cool, wet weather returns. Alternatively, the fungus may remain active throughout the summer if moderate temperatures and rainy conditions persist. The disease becomes increasingly more severe if cool, wet springs occur in successive years. The fungus usually is not moved readily from vine to vine so the disease tends to be localized in the vineyard.

However, the fungus can be moved over long distances to new locations on infected cuttings used for propagation or on contaminated nursery stock.

Disease management. Catawba, Concord, Delaware, and Niagara are very susceptible; Fredonia and Reliance are less susceptible; and Aurore and Baco Noir are only slightly susceptible. The relative susceptibility of many grape cultivars is not known. Follow the recommended cultural practices described earlier to help limit disease development. Be sure to use only pathogen-free stock for grafting or planting and to remove and destroy diseased shoots when pruning. In addition, one to two well-timed fungicide applications usually will prevent new infections. Make the first application when new shoots are 1 to 3 inches long and, if wet weather persists, make another application when they are 5 to 6 inches long.

Powdery mildew

In Wisconsin, powdery mildew is much less important than either black rot or downy mildew and usually causes little or no economic damage. However, on susceptible cultivars and in warm (65° to 80°F), humid weather, it can reduce vine growth, yield, fruit quality, and winter hardiness. The disease is caused by a fungus that only attacks members of the grape family. Many other plants also are affected by powdery mildew, but each plant or group of closely related plants usually is attacked by a unique powdery mildew fungus. Consequently, powdery mildew on one plant usually does not affect other unrelated plants. However, powdery mildew on different plants develops under similar weather conditions.

Symptoms. All green tissues are susceptible to infection. The fungus grows on the surface of infected plant parts and produces an abundance of spores, giving them a dusty or powdery appearance. Lesions on leaves begin as small, white patches; over time, these can coalesce and cover the entire surface. Powdery mildew affects the upper leaf surface more severely than the

lower leaf surface. If young, expanding leaves are infected, they become white and powdery with fungus growth, distorted, and stunted. Infected green shoots typically have lesions that look like dark brown or sooty black patches. Berries also are susceptible. Infection of young berries causes reduced size, failure to color, and splitting that leads to secondary rotting. Berries of red or purple cultivars that are infected as they begin to ripen develop a blotchy or rusty appearance on their surfaces and produce off-flavored wines. Later in the season, small, brown to black, spherical fruiting bodies of the fungus (called cleistothecia) develop on infected plant surfaces.

Disease cycle. The fungus overwinters primarily as cleistothecia on bark or dead leaves. In the spring, wind carries spores to new green tissues. Occasionally, the fungus may overwinter in infected buds, in which case, new shoots become diseased as they grow. New spores form soon after infection and continue forming throughout the season. Spores are dispersed readily by wind, so once the disease has begun, it can spread rapidly through the vineyard. Unlike black rot and downy mildew, plant surfaces do not need to be wet for infection. In fact, rainfall tends to inhibit spore germination and disease development.

Disease management. American grape cultivars tend to be more resistant than French hybrid cultivars. Aurore is highly susceptible; Baco Noir, Concord, Foch, Fredonia, and Himrod are moderately susceptible. The cultural practices described earlier—particularly those that improve air circulation to promote drying in the canopy—may help reduce disease severity. If the disease ever becomes a serious problem, applications of sulfur or other effective fungicides should provide control. However, certain cultivars, such as Concord, Foch, and Maréchal Foch are sensitive to sulfur injury, especially at temperatures of 85°F or higher.

Crown gall

Crown gall, which is caused by a bacterium, affects hundreds of different plants, including grapevines. It is particularly a problem on European and French hybrid grape cultivars that are grown in colder climates where freezing injury is likely to occur and in nurseries where grapevines are propagated.

Symptoms. Galls typically are associated with wounds. They first appear in early summer as coarse, white, fleshy overgrowths that erupt from beneath the bark. Later they become brown, dry, and woody. Galls form most often on the lower trunk just above the soil surface, but they can also appear below ground or farther up the trunk. Frequently, galls occur at graft or bud unions. Large galls can girdle the entire vine. Diseased plants usually grow poorly, have reduced yields, and may even die.

Disease cycle. Crown gall in home plantings most likely occurs through the use of contaminated planting material. The bacteria may spread throughout the infected plant even though the plant appears symptomless. The bacteria also can survive in soil for several years after being introduced on infected plants. Infection occurs through wounds, such as those caused by freezing injury, pruning, or budding and grafting. The pathogen is transmitted easily from plant to plant on contaminated pruning or propagation tools.

Disease management. American grape cultivars tend to be more resistant than French hybrid cultivars; however, some American grape cultivars, like Niagara, are susceptible. Sanitation and cultural practices are the primary means of disease management. The use of only pathogen-free planting and/or propagation stock is essential. Inspect all plant material before purchasing or planting, and reject plants that have galls or overgrowths. If propagating your own plants, disin-

fect working areas and equipment regularly. Bury or mound soil around trunks in the fall to minimize freezing injury. When removing infected plants, include as much of the root system as possible. Chemical controls are not effective or recommended.

PROBLEM SOLVING

Why grapevines fail to bear

There are many reasons why grapevines fail to bear fruit: spring frosts, winter cold injury, age of vines, too little pruning, or incorrect pruning. This section describes the most common problems and how to avoid them (where possible).

Cold injury. Perhaps the most common problem for grapes is cold midwinter temperatures. Fruit buds of American grapes are hardy to about 0°F in early December. A plant's hardiness depends on the weather before a freeze and the duration of the cold. A midwinter warm spell (such as a February thaw) can predispose the vines to injury if a severe freeze follows. Both flower bud and vine injury or death can result from cold winters. French hybrids are less hardy than American grapes and are more likely to suffer winter injury. European grapes are not hardy in Wisconsin.

Once the buds begin to grow they are hardy to about 28°F. If the primary bud is killed, the secondary bud will still grow and produce a small crop. If the secondary bud is killed, smaller buds will produce vegetative growth but no fruit.

Vine age Grapevines generally won't produce any grapes for 3 to 4 years after planting. The plant has to accumulate food resources and the wood has to mature before there is sufficient vine strength to grow fruit. Plants may take several additional years to produce fruit if they have not been pruned and cared for properly. Vines growing in weedy areas may also take longer to produce due to competition for water and nutrients.

Incorrect pruning. The style of pruning is also important. American grapes typically produce fruit at the second to the fifth nodes along a cane. If these grapes are spur pruned to leave only two to three buds per cane, little or no fruit will be produced. French hybrid grapes usually produce fruit at the second and third nodes of a cane. If these grapes are cane pruned to leave five or more buds per cane, they will produce much vegetative growth at the expense of fruit production.

Gender. Some wild grapes have separate male and female plants. Flowers on male plants produce only pollen. Since the male flower has no ovary, no fruit will be produced. Male and female plants look identical except for the difference in flowers. Gender can only be determined by examining the flowers. Grapevines purchased at nurseries should have both male and female flower parts in each flower.

Exposure to herbicides. Grapevines are extremely sensitive to phenoxy herbicides such as 2,4-D and dicamba. Early-season exposure to these herbicides may cause leaf deformity and fruit drop. Late-season exposure is less likely to cause injury. These herbicides are volatile and may travel up to 2 miles from the site of application under the right conditions. If you plant grapevines in rural areas where cash grains or pasture land is common you can expect some injury from phenoxy herbicides.

Poor fruit quality

In some instances grapevines produce fruit clusters that are small or of poor quality. This section describes problems that can lead to poor fruit quality.

Insufficient pruning. Many gardeners leave too many canes (and therefore too many buds) on grapevines. Too much vegetative growth limits the resources available for fruit growth. These vines produce few bunches of small grapes. With too much cane growth the lower and inner parts of the vine are shaded. To correct this problem, follow the pruning advice described in the section on training and pruning.

Neglected vines. Unpruned plants, plants that haven't been trained on a fence or trellis, and diseased or insect-infested plants typically produce poor quality fruit. Heavy pruning and pest management can usually reclaim grapevines.

Poor growing conditions. When grapes are planted in shady spots or on soils that are wet and poorly drained the vines won't thrive. Lack of sunlight will cause long spindly growth. Vines planted in wet heavy soils usually die within a year or two.

Inferior cultivars. Inferior cultivars will produce inferior fruit. Chance seedlings and vines collected from the wild are also likely to produce poor fruit. Good management cannot compensate for poor genetics. For the best chance of success, choose cultivars suggested in this publication.

Why plantings fail

Plant death is usually caused by a number of interacting factors rather than by a single identifiable cause. One injury may provide sufficient stress to allow other problems to kill the vine. Several common reasons for vine death are described below.

Winter injury. Most American grapevines are hardy in Wisconsin on favorable sites. During severe winters even these vines may be injured. European grapes and French hybrids are less hardy. European grapevines will not survive even moderate winters. French hybrids will survive and produce fruit on good sites in southern and eastern Wisconsin. Selecting appropriate cultivars and sites will aid winter survival. Temperatures of -10°F would likely lead to both bud and trunk injury of French hybrids and some primary bud injury to American grapes. Temperatures of -20°F would kill buds and cause significant trunk and cane injury on French hybrid vines. American grapes would suffer less damage, but there would be significant crop reduction. See the section on managing grapes in cold climates for tips on minimizing winter injury.

Too much water. Grapevines will not tolerate "wet feet." Poor soil drainage is common in heavy clay soils and in low spots. Standing water lasting more than a day in summer will likely lead to injury. When soils are flooded, water fills the pores in the soil that would otherwise be filled with air and can provide oxygen to the roots. Root rots are also favored on wet soils.

Too little water. Young grapevines are particularly susceptible to drought. When water is limited, roots cannot provide the water necessary to replace that lost through the leaves. Sandy soils are particularly drought prone. If plants wilt in the afternoon, they need water. Avoid drought stress by watering vines often. Young vines should receive 3 to 5 gallons of water per week. Older, established vines will also benefit from irrigation during dry periods. Grasses growing near the vines will take up most of the available water. Don't allow grass to compete with grapevines.

Physical damage. Vines can be killed when the trunks are seriously injured. String trimmers, lawn mowers, and animals can cause physical injury. If string trimmers and lawn mowers are used too close to trunks, they can damage the layer beneath the bark that carries nutrients to the roots. Avoid damage from lawn equipment by not allowing grass or other vegetation to grow within 2 feet of the vine. This area can be mulched, cultivated, or treated with herbicides. Rodents and rabbits will gnaw on the bark for food in the winter. If they strip off too much bark, the roots won't get the nutrients they need and the vine will die. Eliminate rodent habitat by removing vegetation from around vines, including any tufts growing up against the trunk, and by keeping adjacent areas mowed (especially in the fall). This will reduce rodent populations and the likelihood of injury.

**Arm**

A short branch extending from the trunk or cordon on which canes or spurs are borne.

Cane

A one-year-old shoot.

Cane prune

A pruning technique where canes with 8–15 buds are left to produce shoots and fruit the following year.

Cordon

A horizontal extension of the grapevine trunk. It is usually trained along the trellis wire. A cordon is a permanent part of the vine.

Cordon train

A training system where cordons are maintained on the vine. The Geneva double curtain is an example.

Cultivar

A contraction of “cultivated variety.” Describes plants that are distinguishable by distinct characteristics.

Fruiting wood

One-year-old canes that will produce the current season’s crop.

Head

The top of the vine where canes and renewal spurs arise.

Head train

A training system where canes and renewal spurs arise directly from the top of the trunk. No cordons are retained.

Node

The thickened portion of a shoot or cane where leaves arise and where the compound bud is located.

Renewal spur

A cane pruned to one to three buds. The spur will produce a cane that will fruit the following year. These generally arise from the cordon or head.

Spur

A cane pruned to one to three buds. A fruiting spur produces shoots with fruit.

Spur prune

A pruning method where canes are pruned to one to three buds. This technique is generally used with European-type grapes.

Trunk

The main upright stem of grapevines from which cordons, canes, spurs, and shoots may arise. The trunk usually lasts for many years.



RELATED PUBLICATIONS

Grape Pest Management for Home Gardeners
(A2129)

Fertilizing Small Fruits in the Home Garden
(A2307)

Home Fruit Cultivars for Northern Wisconsin
(A2488)

Home Fruit Cultivars for Southern Wisconsin
(A2582)

Midwest Small Fruit Pest Management
Handbook (Bulletin 861, Ohio State University)

^{UNW} **Extension**

Copyright © 2006 by the Board of Regents of the University of Wisconsin System doing business as the division of Cooperative Extension of the University of Wisconsin-Extension. Send inquiries about copyright permission to: Manager, Cooperative Extension Publishing, 432 N. Lake St., Rm. 103, Madison, WI 53706.

Authors: Teryl Roper is professor of horticulture, Dan Mahr is professor of entomology, and Patty McManus is professor of plant pathology, College of Agricultural and Life Sciences, University of Wisconsin-Madison and University of Wisconsin-Extension, Cooperative Extension. Brian Smith is professor of horticulture, College of Agriculture, University of Wisconsin-River Falls and University of Wisconsin-Extension, Cooperative Extension. Produced by Cooperative Extension Publishing. Pruning illustrations and graphic design by Jody Myer. Cover illustration by Catherine Baer, copyright 1998. Japanese beetle illustration by David Shetlar.

University of Wisconsin-Extension, Cooperative Extension, in cooperation with the U.S. Department of Agriculture and Wisconsin counties, publishes this information to further the purpose of the May 8 and June 30, 1914 Acts of Congress; and provides equal opportunities and affirmative action in employment and programming. If you need this material in an alternative format, contact the Office of Equal Opportunity and Diversity Programs or call Cooperative Extension Publishing at (608) 262-2655.

This publication is available from your Wisconsin county Extension office or from Cooperative Extension Publishing. To order, call toll-free 877-WIS-PUBS (947-7827) or visit learningstore.uwex.edu.

NURSERIES

This list of nurseries is provided as a convenience for our readers. It is not an endorsement by Extension nor is it exhaustive. These plant materials may be available from other equally suitable nurseries.

J.W. Jung Seed
335 South High Street
Randolph, WI 53957
(800) 247-5864
www.jungseed.com

Lon J. Rombough
P.O. Box 365
Aurora, OR 97002
(503) 678-1410
www.bunchgrapes.com

McKay Nursery
P.O. Box 185
750 South Monroe St.
Waterloo, WI 53594
(800) 236-4242
www.mckaynursery.com

Miller Nurseries
5060 West Lake Road
Canandaigua, NY 14424
(800) 836-9630
www.millernurseries.com

St. Lawrence Nurseries
325 State Highway 345
Potsdam, NY 13676
(315) 265-6739
www.sln.potsdam.ny.us